

DELIVERING FOR GLOBAL INDUSTRIES



WE DELIVER FOR WORLD LEADERS

Volga-Dnepr Group is the world leader in the oversized and super-heavy cargo transportation market. It includes several cargo carriers which provide air freight logistics solutions worldwide and enable global customers to achieve fast, secure and cost-efficient transportation, even for the most complex shipments.

VOLGA DNEPR
#7 8422 59 00 59
#7 8422 20 26 75
<http://www.volga-dnepr.com>

1,200

airports in 190 countries served
by the Group's airlines to date



5,000,000

tonnes of cargo carried since 1990





UNIQUE TRANSPORT & LOGISTICS SOLUTIONS

Volga-Dnepr Airlines is the part of Volga-Dnepr Group which performs charter operations worldwide for the benefit of its international customers.

Established in 1990 in Ulyanovsk (Russia), it created and gradually developed a new international market segment for non-standard (outsize and heavy) cargo transportations.

Nowadays, Volga-Dnepr Airlines is the world leader in its niche market and the largest An-124-100 freighter operator. For over 29 years, it has been transforming the transport

and logistics concept, providing its customers with timely, reliable and cost-efficient solutions for even the most complex cargo projects for various industries, including aerospace, oil and gas, automotive, energy, and others.

Volga Dnepr's unique fleet of 12 giant An-124-100 freighters provides both nose and rear ramp loading capabilities as well as onboard cranes and winches,

while its five modernized Il-76TD-90VD cargo aircraft are equipped with an expanding rear ramp, hoists and winches and meet all ICAO requirements for international flight operations in compliance with the latest noise and emissions standards. Both types of aircraft are self-sufficient in remote locations or where local infrastructure is insufficient or has been damaged.

12x
An-124-100

5x
Il-76TD-90VD

18x
Boeing 747

5x
Boeing 737

Volga-Dnepr Group

Volga-Dnepr Group consists of more than 20 companies in nine countries. At the heart of the Group are two core cargo services:

CHARTER OPERATIONS

Global air cargo charter services delivered by Volga-Dnepr Airlines – the world's largest transporter of outsize and heavyweight air cargo, and the provider of end-to-end engineering and logistics solutions. Our air charter services combine all of the operating capabilities of our An-124-100, Il-76TD-90VD, Boeing 747 and B737 freighters.

SCHEDULED OPERATIONS

International scheduled cargo services are delivered by the Group's AirBridgeCargo Airlines and ATRAN Airlines onboard Boeing 747 and Boeing 737 freighters between Russia, Asia, the Middle East, Europe and North America. The combined network of both carriers covers more than 40 destinations worldwide, with all flights operated into international cargo hubs offering fast, efficient and secure handling of any type of cargo.

ADDITIONAL
RESOURCES
AVAILABLE



WORLDWIDE REACH GLOBAL EXPERTISE

VOLGA-DNEPR GROUP OPERATIONS TO DATE FOR KEY INDUSTRY VERTICALS

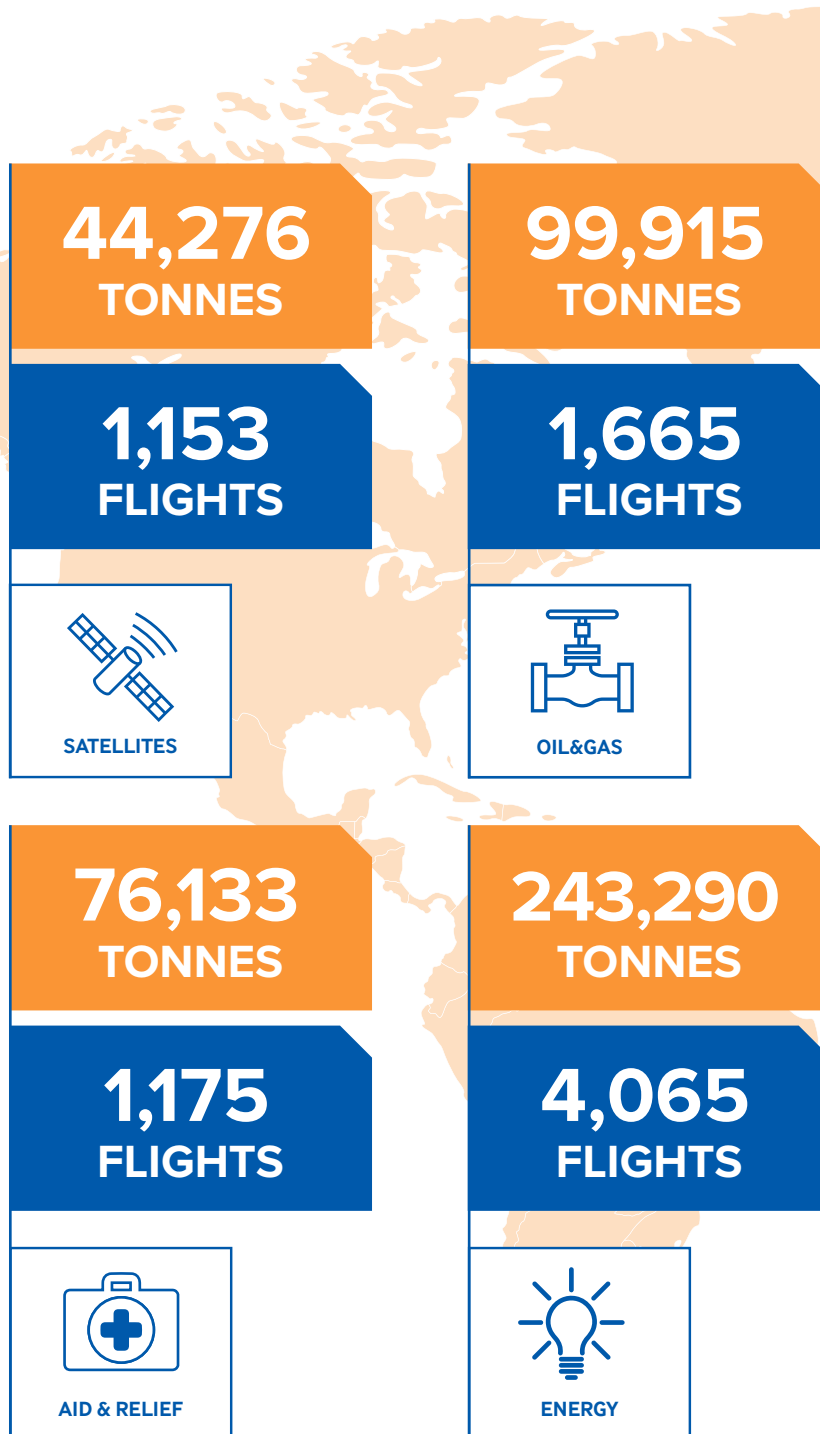

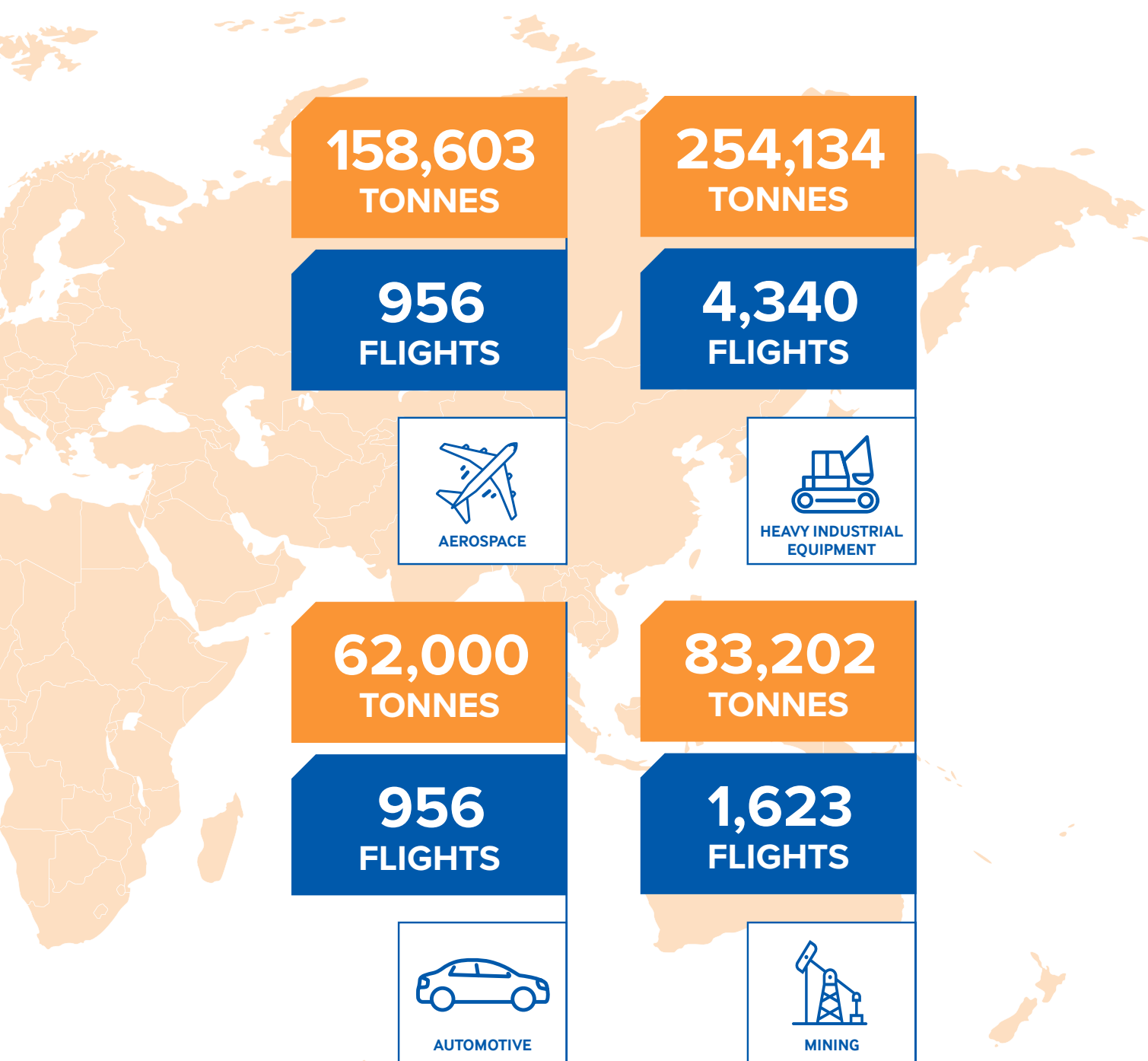

Note: Statistics up to and including 2018.

An-124-100

AIRCRAFT SPECIFICATIONS

Engine type	4x Lotarev D-18T
Engine take-off thrust	4x 24 T Σ= 96 T
Maximum take-off weight	392,000 kg
Operating empty weight	193,000 kg
Maximum payload incl. equipment weight	120,000 kg
Maximum landing weight	330,000 kg
Maximum zero fuel weight	306 000 kg
Cruising speed	750 km/h
Cruising altitude	31,000 – 35,000ft
Payload / Range	120,000kgs / 4,500 km
Maximum single lift with internal cranes	20,000 kg
Engineering crew	7
Flight crew	6

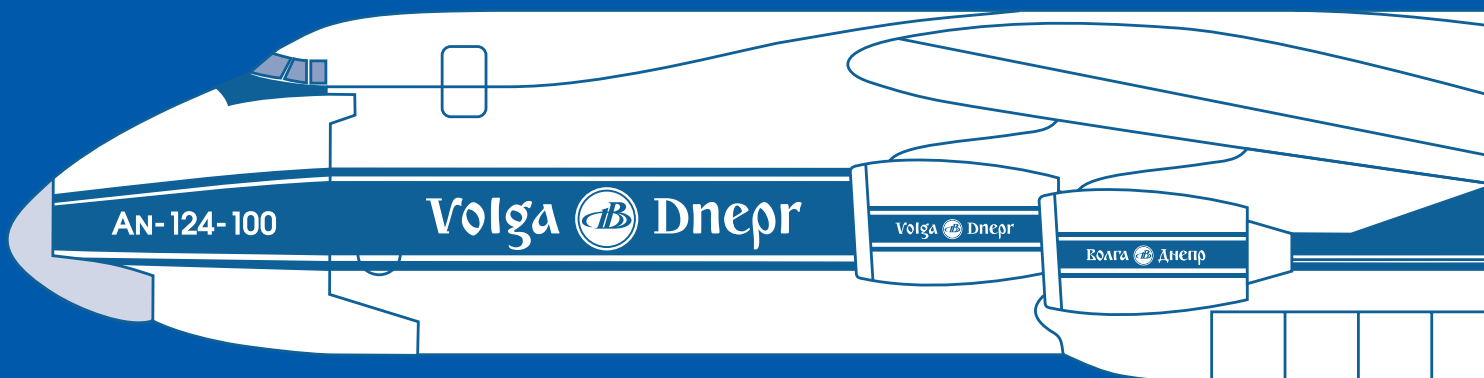

The An-124-100 is the world's largest civil cargo aircraft of serial production, and an acknowledged leader of the air cargo market for the transportation of oversized and super-heavy shipments.



The combination of exceptional characteristics such as its cargo compartment size, flight range and uplift capability without using special loading equipment, allows the An-124-100 to carry super-heavy and oversized cargo up to 120 tonnes across the greatest range.

LOADING EQUIPMENT

- Internal Crane System – The onboard system of overhead cranes consists of 2 gantries with 2 hoists, each equipped with 2 lifting hooks. They are capable of lifting single items of up to 20,000kgs. Our special extension for the onboard crane can be fitted to increase capacity to 30,000kgs but restrictions apply
- Double deck loading and transport system

Designed and patented by Volga-Dnepr, it allows the An-124-100 to transport up to 55 cars or 40 jeeps on a single flight, depending on the vehicles' characteristics. Loading does not require any additional equipment. Alternatively, cars can be driven or winched through the nose

- Bearings for elements of the front aircraft ramp or, to put it simply, under the front ramp of the An-124-100

- Extension ramps of various types
- Tracking systems (similar to railway tracks) 2 versions: low-profile and standard-profile
- Skate beams, roller frames or roller beams
- Platforms of various design and load-carrying capacity
- Protective weight-distributing plating



Frame No. 42

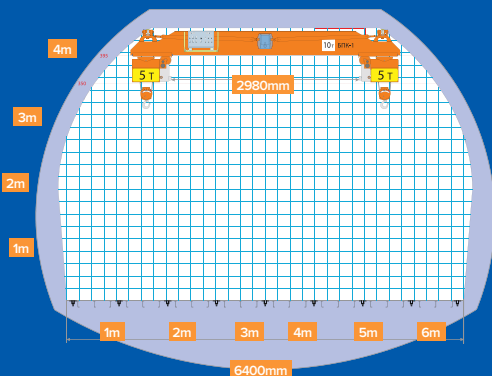

AIR PRESSURE

- Minimum pressure (unpressurised cargo cabin)– 260 mbar
- Minimum pressure (pressurised cargo cabin) – 480 mbar (ΔP 0.25) +0/1/-0.02 kg/cm²
- Air pressure change rate – 70 mbar/min

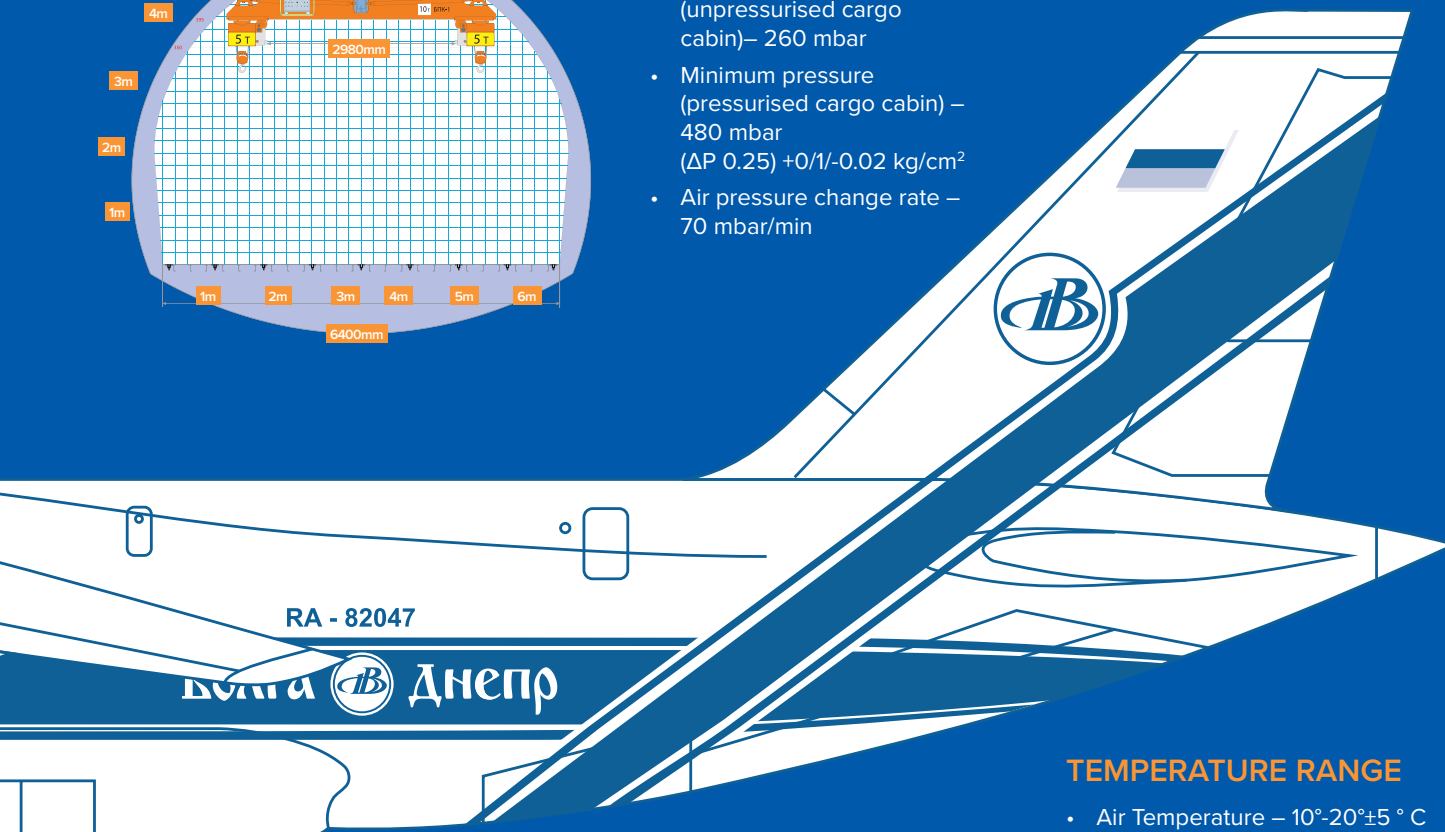

TEMPERATURE RANGE

- Air Temperature – 10°-20±5 ° C
- Humidity during flight – 10-15% RH



ENVIRONMENT IN THE CARGO CABIN

G-Factors

- Forward – 2.3g
- Backward – 1.5g
- Lateral – 1.5g
- Upward – 2.0g
- Down – 2.5g

The lashing and preparation of cargo for flights must be done in respect of these maximum values.



LOADING METHODS

- Pallets & crates loaded by forklift
- Use of the internal crane system
- Vehicles driven or winched into the aircraft
- Vehicles loaded on the Car Rack System
- Heavy or outsize items winched into the aircraft using the tracking system

Cargo capabilities

Dimensions:
L 36.5 m x W 6.4 m x 4.4 m

Loadplan including ramps

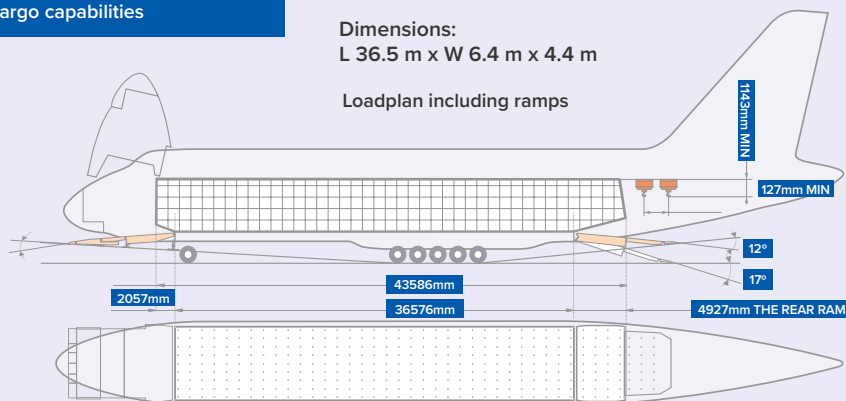

ИI-76TD-90VD

AIRCRAFT SPECIFICATIONS

Engine type	4x PS-90A-76
Engine take-off thrust	4x 16000 kg f Σ = 64000
Maximum take-off weight	195,000 kg
APS weight (average)	98,950 kg
Maximum payload incl. aircraft equipment	45,000 kg
Maximum landing weight	155,000 kg
Maximum ZFW	144,800 kg
Cruise speed	750 km/h
Flight level (typical)	9100 m – 10600 m
Cargo weight / Flight range	45,000 kg / 4500 km
Capability of onboard crane system	12,000 kg
Engineering crew	4 crew members
Flight crew	4 crew members

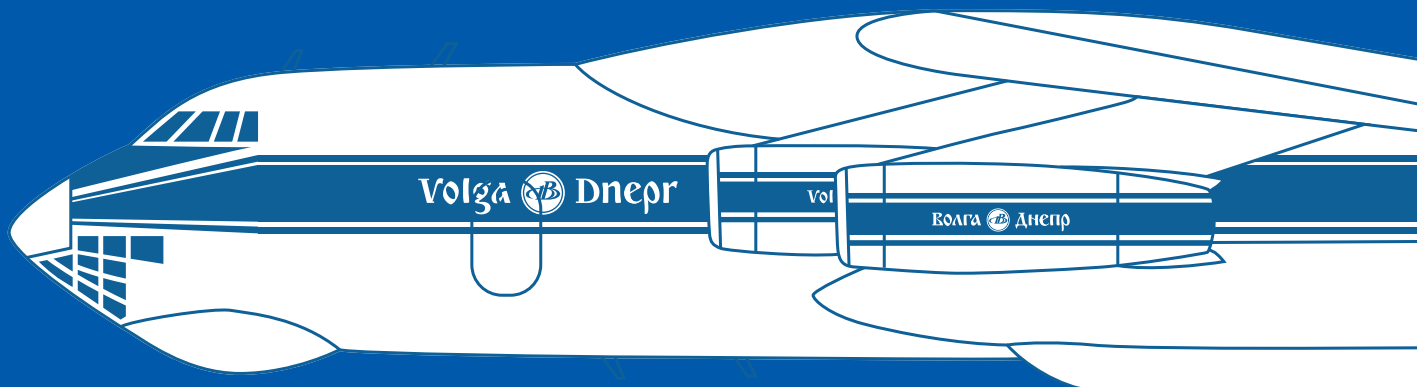

Volga-Dnepr participated in the modernization of the II-76TD, one of the most successful cargo aircraft with its cabin size, carrying capacity and autonomous loading capabilities.



The resulting product is the II-76TD-90VD, equipped with new PC-90A-76 engines and modern avionics, approved for worldwide operations.



LOADING EQUIPMENT

- Upper Loading Equipment
 - 2 onboard electric winches – 3 tonne hauling capacity
 - 4 electric hoists – 3 tonne lifting capacity each
- Loading of wheeled vehicles, trailers and tracked vehicles
 - Ramp enables wheeled vehicles to be loaded using their own power
 - Extension ramp can be applied for the loading of long and high vehicles
- Loading of heavy and outsize cargo
 - Use of special Volga-Dnepr Airlines' loading equipment
 - Mobile crane(s) and additional trailers must be used

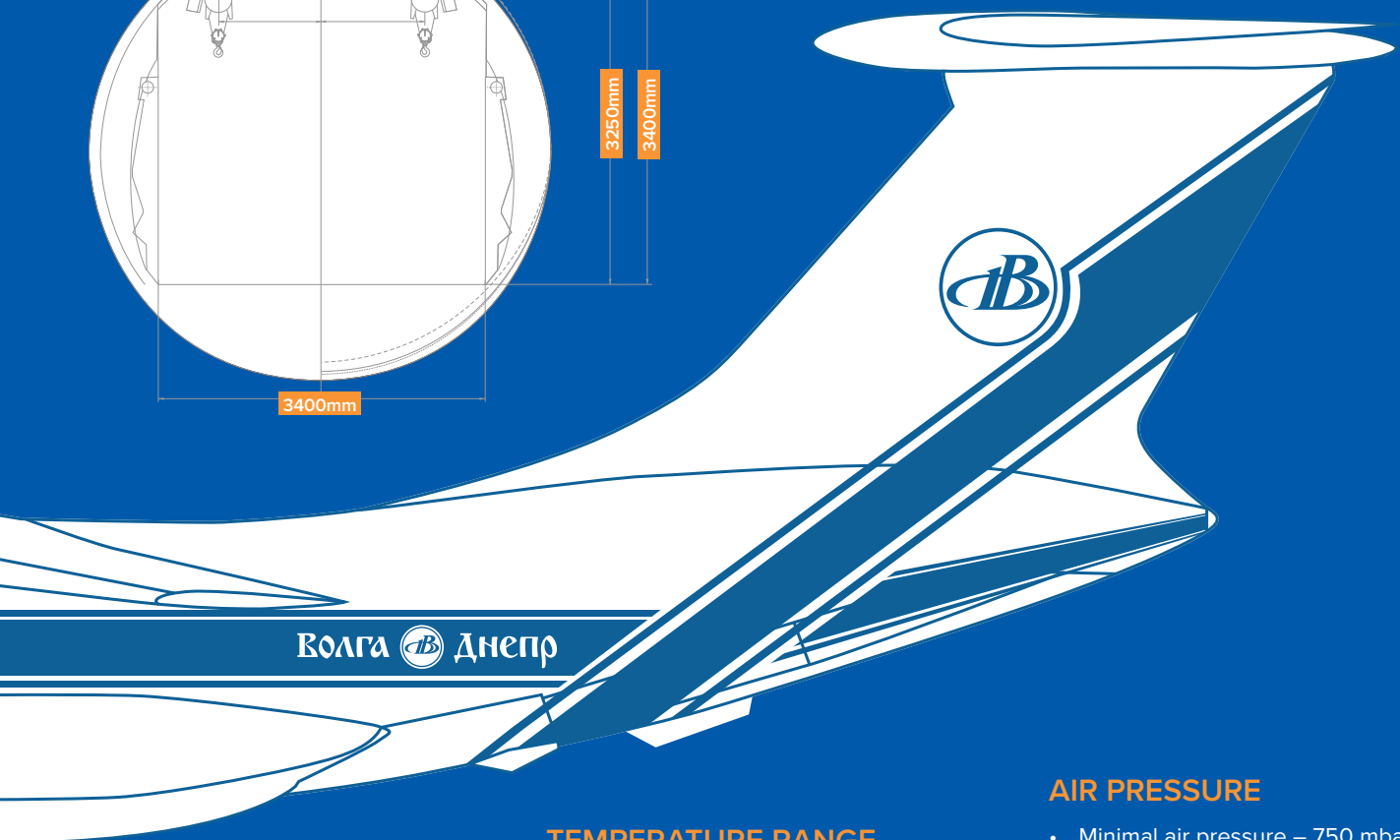
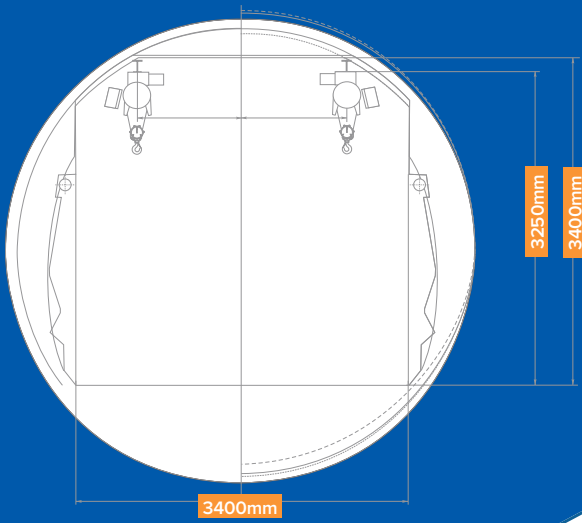

Волга  Днепр

TEMPERATURE RANGE

- Air Temperature – 10°-20°±5 ° C
- Humidity during flight – 10-15% RH

AIR PRESSURE

- Minimal air pressure – 750 mbar (2 500m) Δ P 0.52 kg/cm²
- Air pressure change rate – 15 mbar/min

ENVIRONMENT IN THE CARGO CABIN

G-Factors

- Forward – 2.23g (up to 6.0g in case of emergency landing)
- Backward – 1.5g
- Lateral – 1.5g
- Upward – 2.0g
- Down – 2.5g

The lashing and preparation of cargo for flights must be done in respect of these maximum values.



Cargo capabilities

Loadplan including ramps

Dimensions:
L 18.5 m x W 3.4 m x 3.35 m

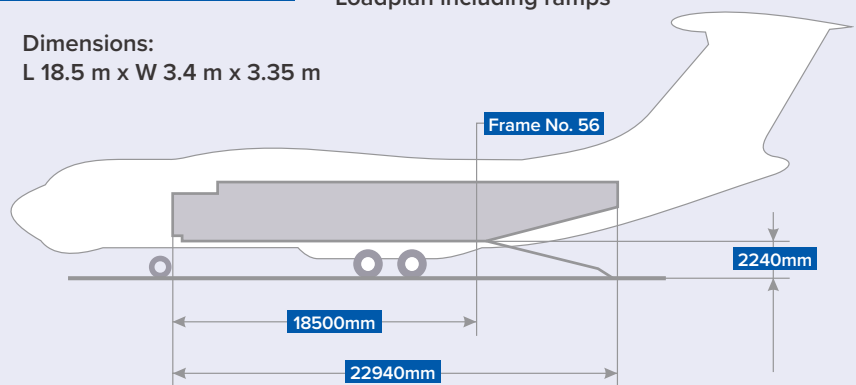

Boeing 747

AIRCRAFT SPECIFICATIONS

Boeing 747-8F	
Maximum take-off weight	447,695 kg/975,000 lb
Maximum landing weight	329,761 kg/761,000 lb
Maximum payload	139,000 kg
Main deck volume	692.7 m ³ / 24,462 ft ³
Lower hold volume	150 m ³ / 5,330 ft ³
Bulk	14 m ³ / 496 ft ³
ULD main deck	34 positions
ULD lower deck	12 positions
Boeing 747-400F (ERF)	
Maximum take-off weight	412,796 kg/910,000 lb
Maximum landing weight	296,195 kg/653,000 lb
Maximum payload	128,500 kg
Main deck volume	607.7 m ³ / 21,462 ft ³
Bulk	130.3 m ³ / 4601 ft ³
Lower hold volume	14 m ³ / 520 ft ³
ULD main deck	30 positions
ULD lower deck	9 positions

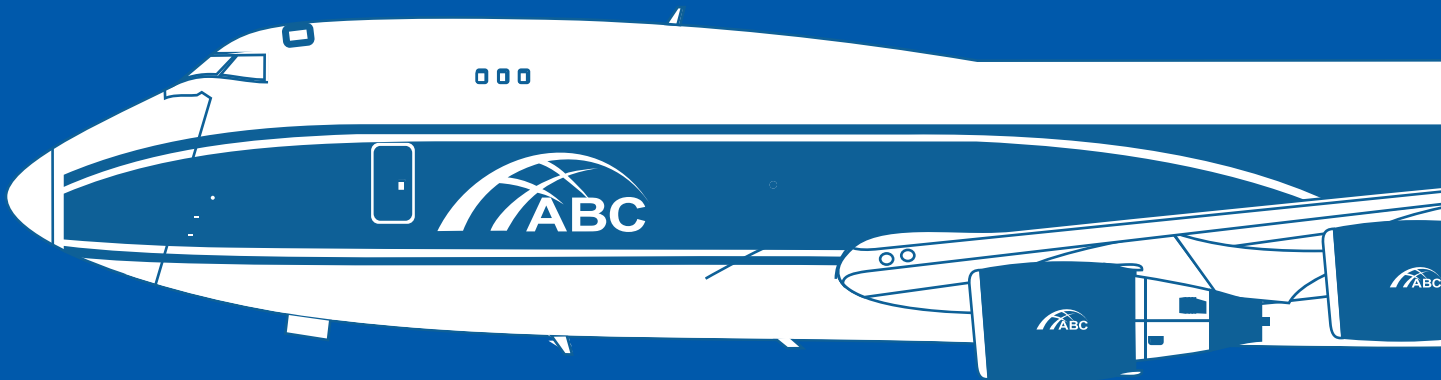

The Boeing 747 is an all-cargo aircraft and is one of the most popular choices for cargo transportation.

 Features such as the large side door and swing up nose door facilitate the ease and flexibility of loading.



Temperature Controlled Logistics

The Boeing 747-8F and 747-400F (ERF) both contain three compartments enabling different temperature settings from 4°C to 29°C.

Aircraft dimensions

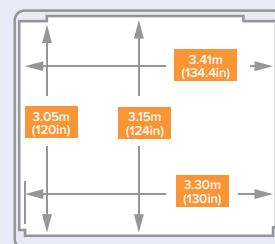

Main deck cargo door (STA 1770) Left-hand side

Fwd lower deck cargo door (STA 615) Right-hand side

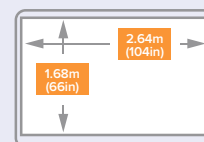

Aft lower deck cargo door (STA 1865) Right-hand side

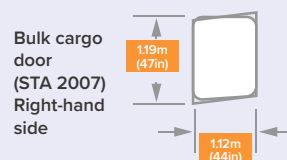
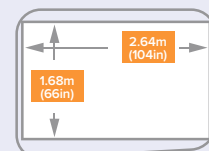

Bulk cargo door (STA 2007) Right-hand side

ULDs

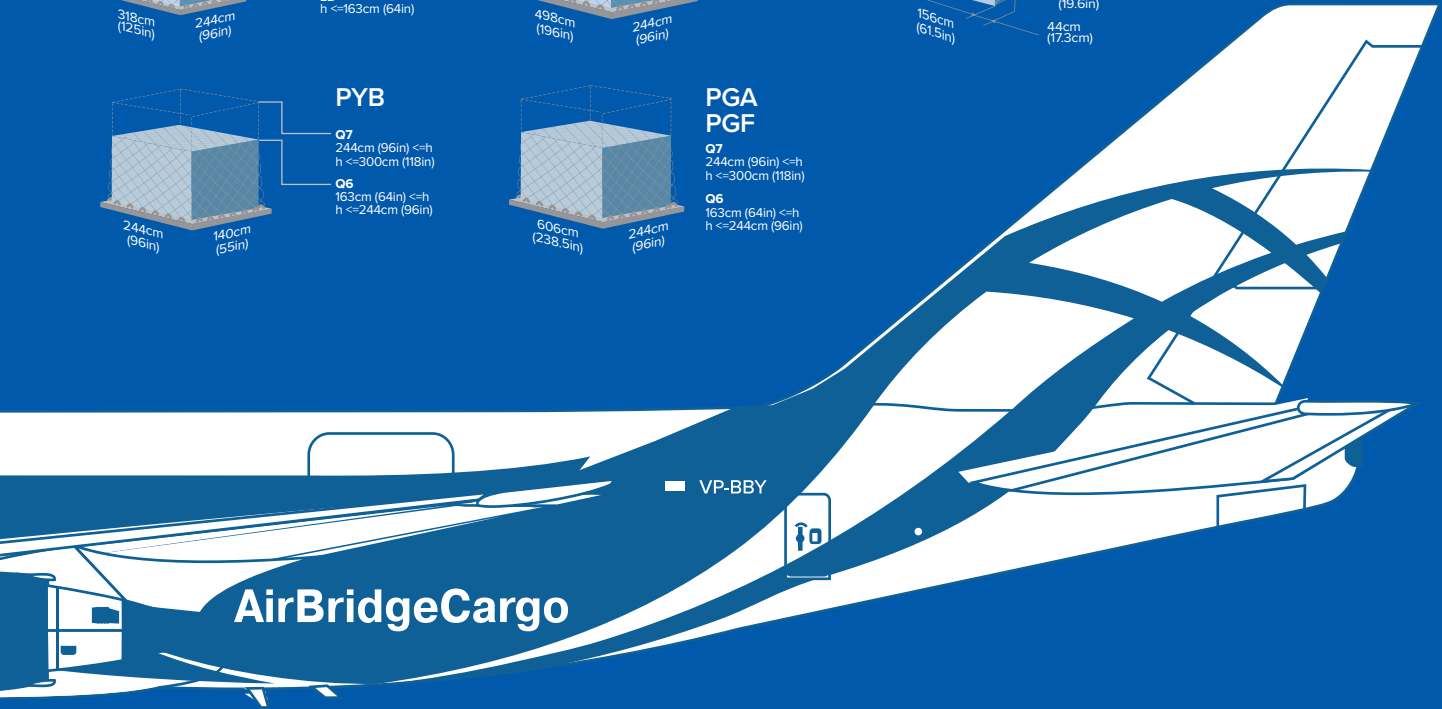
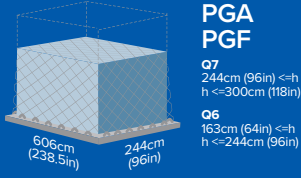
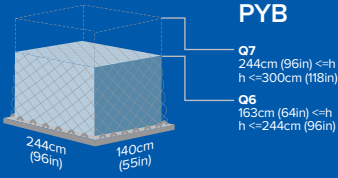
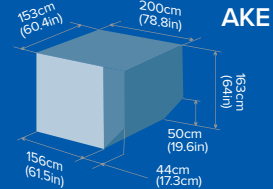
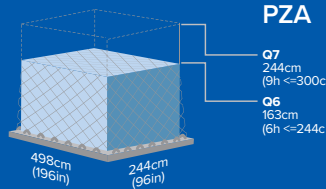
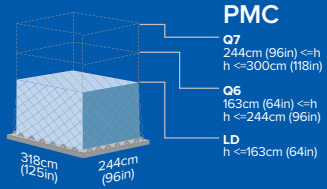

Aircraft dimensions

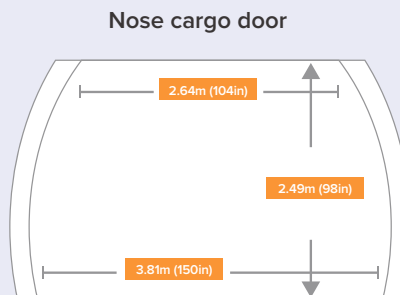
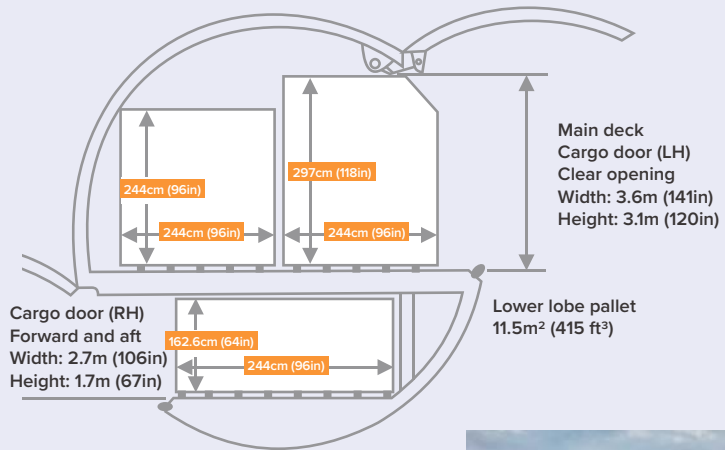
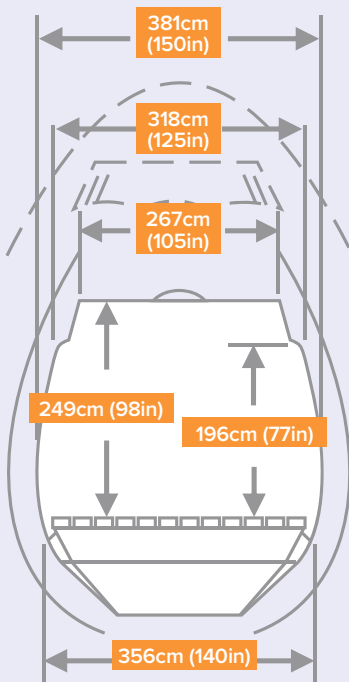

Boeing 737

AIRCRAFT SPECIFICATIONS

Boeing 737-800BCF

Maximum take-off weight	79,000 kg / 174,200 lb
Maximum landing weight	66,350 kg / 146,300 lb
Maximum payload	23,950 kg
Main deck volume	141.5 m ³ / 4,997 ft ³
Pallets and containers with base 88" x 125", total number 11+1	

Boeing 737-400SF

Maximum take-off weight	65,090 kg / 153,500 lb
Maximum landing weight	55,338 kg / 122,000 lb
Maximum payload	20,000 kg
Main deck volume	130 m ³ / 122,000 lb
Pallets and containers with base 88" x 125", total number 10+1	



The Group's Boeing 737-400SF and 737-800BCF are twin-engine medium-haul aircraft that are perfectly suited to short and mid-range routes.



They are able to carry up to 23 tons and 141.5 m³ of cargo to a distance of 3,750 km kilometres. The 737 aircraft is equipped with a main deck side cargo door and a loading system enabling it to stow 10 standard 2235x3175 mm aviation pallets and containers in the cargo hold.

LOADING HEAVY CARGO

- The maximum weight for one piece of cargo is 3,200kg, on the condition that the dimensions of this piece do not exceed the dimensions of the pallet
- With a new scheme developed by ATRAN Airlines, should the cargo not exceed dimensions of 200 x 140 x 150cm, the weight of the cargo can be up to 6t

LOADING METHODS

- Loading oversize cargo (Main deck)
- Dimensions up to 380 x 100 x 100cm and must be reinforced on a pallet and loaded by the wide side of the pallets, turning 90 degrees on entrance to the main deck
- Loading cargo at an angle to the door of the main cargo decking



CARGO CAPABILITIES

Boeing 737-400SF

- Length 36.4 m / 119 ft
- Height 11.07 m / 36 ft
- Wing span 28.88 m / 94 ft

Boeing 737-800BCF

- Length 39.5 m / 129 ft
- Height 12.54 m / 41 ft
- Wing span 35.8 m / 117 ft

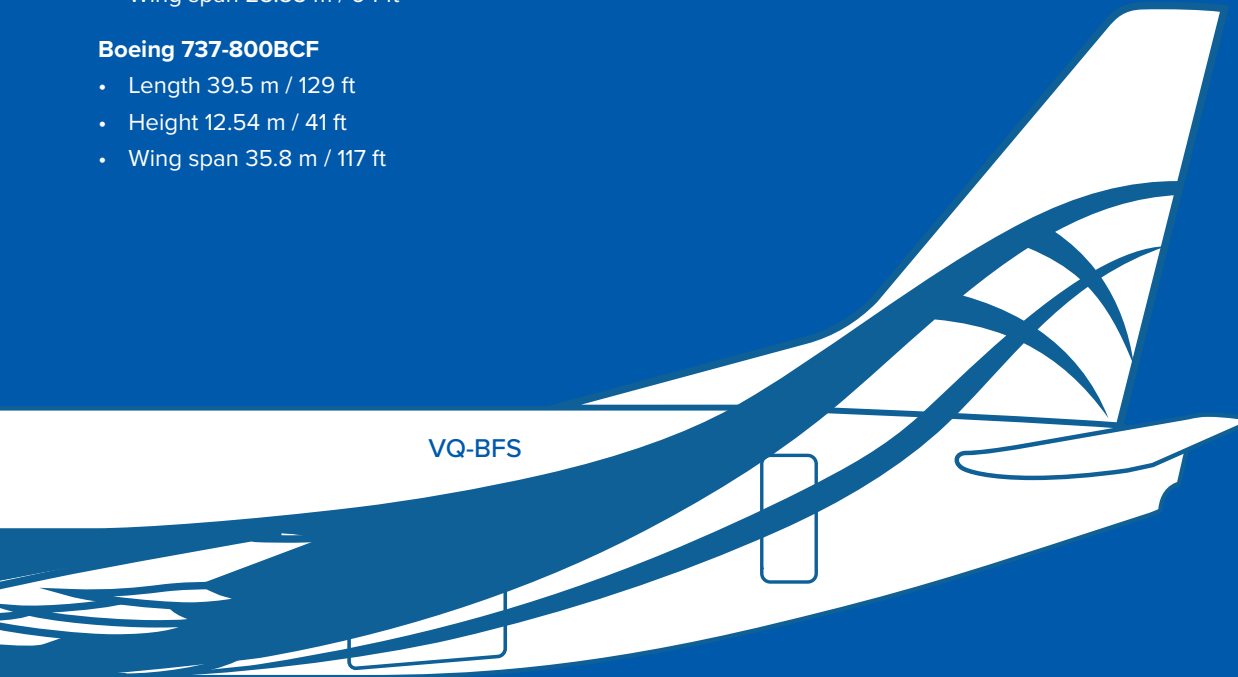

Aircraft dimensions

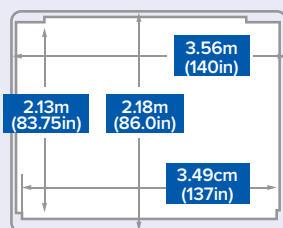

Main deck
cargo deck

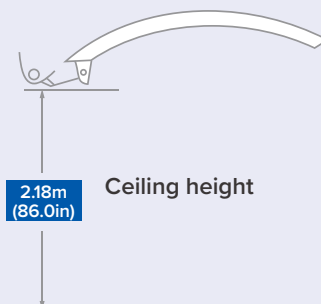

Ceiling height

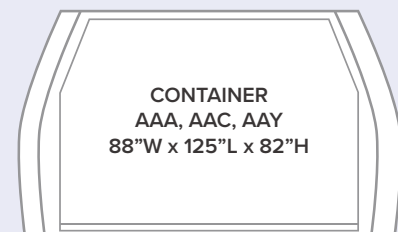

Position 1-10

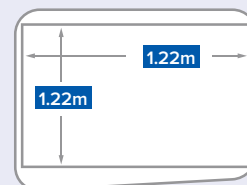
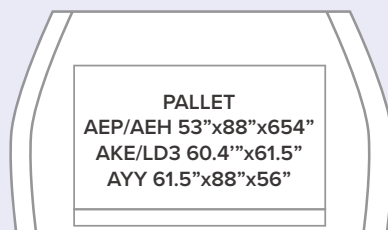

Aft lower deck
cargo door

ATRAN AIRLINES OPERATES 5 BOEING 737 FREIGHTERS

A TOTAL LOGISTICS SOLUTION



Site visits to conduct engineering and technical assessments of cargoes for transportation



Consultancy ahead of the product manufacturing process to ensure the cargo is capable of being transported without any delays or unexpected costs



Design and manufacture of special frames to enable loading and transportation of the cargo

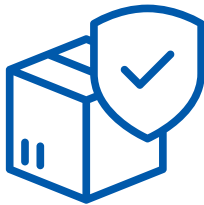

Packaging advice and support to ensure the integrity of the cargo throughout the transportation process



Optimal route planning from production site to final destination



Ground support arrangements at airports for loading/unloading, cargo delivery to/from the airport and obtaining all necessary authorisations, approvals and permits



Assistance with customs clearance, insurance and warehousing of cargo

VOLGA-DNEPR'S TRANSPORT AND LOGISTICS EXPERTS ARE CONTACTABLE 24/7



THE PROCESS OF MOVING YOUR CARGO

Once we receive your request, the delivery of your cargo is managed through 8 key stages:

- 1 Development of logistics solutions
- 2 Load planning
- 3 Commercial & navigation checks
- 4 Calculate the cost
- 5 Optimal option agreement & contract
- 6 Preparation of your cargo
- 7 Transportation
- 8 Client consultation to gain service feedback and to discuss future requirements

ASK OUR EXPERTS FOR HELP & ADVICE

Our specialists are available 24/7/365 to answer your questions on:

- Involving us during the design stage of your cargo to ensure transportation requirements are incorporated in the manufacturing process to avoid additional costs or delays to your delivery schedule
- Appropriate cargo rigging and mooring sites
- Packaging to sustain all maximum operating conditions inflight
- Air pressure requirements to avoid damage
- Design and manufacturing of frames to support your cargo
- Advice on hazardous goods
- Help with designs for special shipping containers
- Recommendations on methods of loading and unloading
- Preparation of cargoes to ensure minimal dismantling prior to carriage
- Temperature and pressure requirements in the aircraft's cargo cabin

We have local experts, loading equipment and aircraft positioned at all of our global operations bases so our fast, efficient and cost-effective delivery solutions are always close at hand.

AEROSPACE



TRUSTED LOGISTICS PARTNER TO THE GLOBAL AEROSPACE INDUSTRY

With over 29 years' experience of delivering solutions for international Aerospace supply chains, Volga-Dnepr is regularly called into action to keep production lines moving, to help airlines quickly resolve urgent Aircraft-on-Ground (AOG) situations, to deliver new helicopter models to airshows around the world, and to ensure satellites carrying the latest telecommunications technologies can be launched into space on schedule.

Whatever the challenge, our team of Aerospace experts will provide you with the most time- and cost-efficient delivery solution to meet all of your requirements.

Whether we are tasked with moving 787 Dreamliner wings from Japan to Boeing's assembly plant in the US, delivering satellites to launch sites in the United States or South America, moving Super Puma and Sikorsky helicopters from the Falkland Islands to the USA and Norway, or racing aero engines to fix AOG scenarios at airports across the globe, our customers always trust us to deliver as promised.

Our experts offer 24/7/365 advice and support and are ready to help make your transportation needs as simple as seamless as possible, including:

- Support during the design stages of fuselage sections, wings and stabilizers to ensure your transportation requirements are incorporated ahead of manufacture
- Advice on appropriate cargo rigging and mooring sites

- Packaging to sustain all maximum operating conditions inflight
- Air pressure requirements to avoid damage
- Liaison over frames to be used to carry your cargo and advice, design and manufacturing of frames, if required
- Advice in relation to hazardous goods
- Help with the design requirements for satellite transportation containers
- Recommendations on methods of loading and unloading
- Preparation of helicopters to ensure minimal dismantling prior to carriage and to equalize air pressures
- Your requirements for temperature and pressure in the aircraft's cargo cabin

As a valued customer of Volga-Dnepr, our professionals are part of your team throughout your cargo's safe and secure journey with us.

SATELLITE MANUFACTURERS

- Airbus Defence & Space
- Mitsubishi Electric Corporation
- Russian Federal Space Agency
- Space System Loral
- Thales Alenia Space

HELICOPTER MANUFACTURERS & OPERATORS

- Airbus Helicopters
- AgustaWestland
- Bell Helicopter
- Boeing
- Erickson Air-Crane
- MD Helicopters
- Russian Helicopters
- Sikorsky Aircraft Corporation

AIRCRAFT & PARTS MANUFACTURERS

- Airbus
- Boeing
- Bombardier
- GE Aviation
- Pratt & Whitney
- Rolls-Royce
- United Aircraft Corporation



LEARN MORE...

AOG SERVICES



FAST RESPONSE AOG SOLUTIONS

Our AOG solutions combine all of the best practices and experience of Volga-Dnepr Group's global team, developed over more than 29 years of serving customers worldwide. The Group's three airlines, together with its strategic partner, CargoLogicAir, are always ready to manage every AOG request.

Volga-Dnepr Group's highly-experienced and skilled professionals have a proven track record of tackling every aspect of the transportation and logistics process, no matter how complex or extreme the challenge may seem.

We understand that airlines all over the world are focusing on improving the reliability of their services through expansion of their fleets, route networks and optimization of their aircraft and engines. This is why it is important to have the complete peace of mind of knowing pre-emptive solutions are in place to handle AOG situations and to ensure minimal impact to their routine operations.

Our AOG service has been designed by our airline industry experts to deliver this assurance. Volga-Dnepr's AOG team includes specialists from Volga-Dnepr Technics, our dedicated provider of MRO services to various types of aircraft. The AOG team guarantees an immediate response to AOG situations at any location worldwide, including the provision of highly qualified personnel on-site to perform aircraft inspection and assessment scopes, ordering and replacing required parts and components, and processing relevant records.

Supported by a 24/7 team of aviation professionals and logistics practitioners, our dedicated AOG service offers the fastest and most cost-efficient solutions. The Group's unique Boeing 747, Boeing 737, An-124-100 and Il-76TD-90VD fleet enables smooth and seamless air charter and scheduled cargo services, including the ability to carry AOG spares onboard the Group's first available scheduled services in Europe, North America and Asia Pacific.

SATELLITES



1,153

... FLIGHTS AND COUNTING

OIL & GAS



PROVIDING PREDICTABILITY FOR GLOBAL OIL & GAS INDUSTRY LEADERS

When the world's leading Oil & Gas companies need an urgent delivery of replacement parts or a guaranteed, on-time delivery to the site of a major O&G project, they understand Volga-Dnepr's experts will offer the best solution for every challenge.

Since 1990, Volga-Dnepr has ensured safe and on-schedule movements of the most diverse range of Oil & Gas cargoes, even to the most remote parts of the world.

From single flights carrying oil pumps from the Netherlands to Turkmenistan or 100 tonnes of pipes to Brunei, finding a bespoke shipping solution for a 38.4m stripping tower from the US to Iraq, or creating a unique 80-flight 'airbridge' to safely transport 6,000 tonnes of vital equipment to a new gas conditioning plant in the highlands of Papua New Guinea, we always create the most optimum solution.

When production stops unexpectedly, when contracts demand resilient delivery guarantees or when new exploration and processing sites are in development, companies throughout the Oil & Gas industry know Volga-Dnepr is a partner they can count on.

For over 29 years, the world's leading Oil & Gas companies have entrusted Volga-Dnepr Group with their most important and complex supply chain challenges.

Our customers include:

- Halliburton
- Schlumberger
- Exxon Mobil
- TOTAL
- BP
- Shell
- Cameron
- ABB
- FMC Technologies
- SINOPEC
- Fluor
- One Subsea
- Atlas Copco
- Baker Hughes
- Weatherford

UPSTREAM

- Drilling equipment
- Pumps
- Power houses
- Blowout preventers
- "Christmas trees"

MIDSTREAM

- Tube bundles
- Pipeline valves
- Vents
- Pipe layers

DOWNSTREAM

- Compressors
- Heat exchangers
- Stabilizers
- Control units



FLIGHTS

1,665



TONNES CARRIED

99,915



ENERGY



OPERATING AT THE HEART OF ENERGY & POWER PROJECTS ALL OVER THE WORLD

Offering reliable transportation solutions for Energy & Power customers has been a core component of Volga-Dnepr's business since the very beginning.

The quality and value of our services have earned us client relationships with highly-respected companies across the industry, including leaders such as:

- Siemens
- APR Energy
- Power Machines
- Aggreko
- Voith Hydro
- Mitsubishi Hitachi Power Systems
- Mitsubishi Heavy Industries

The types of renewable and non-renewable energy and power cargoes we are asked to deliver include rotors from Germany to India, heavy mobile power generators from France and Dubai to customers in Nigeria and Harare, as well as unique outsize and heavyweight cargoes, including a 73-tonnes runner from Austria to Russia, and series of flights such as for the movement of generators to increase power plant capacity in Madagascar.

The size and complex nature of many energy cargoes require specific technical solutions to ensure they can be loaded and unloaded safely and reach their destinations on-time and ready to meet the customers' requirements. Volga-Dnepr's knowledge of moving such cargoes helps customers save time and money and to always achieve their delivery targets.

Since 1990, our unique fleet of An-124-100, Il-76TD-90VD and Boeing 747 freighters have enabled Volga-Dnepr's clients to ship generator rotors, gas and steam turbine rotors, containerized power generating units, transformers and switchgear to customers all over the globe.

Using our special, patented loading systems and 3D modelling technologies for 'virtual' load planning, we will ensure your cargo is delivered as booked, no matter how big your delivery challenge may be.

POWER GENERATION

- Generator rotors
- Heavy-duty gas turbine (HDGT) rotors
- Industrial gas turbines (IGT)
- Aero-derivative gas turbines (AGT)
- Diesel generator sets
- Mobile gas turbine packages
- Hydroturbine runners
- Wind turbine components
- Equipment and supplies for nuclear power plants

POWER TRANSMISSION AND DISTRIBUTION (T&D)

- Transformers
- Power cables
- Electric components
- Mobile substations

OTHER POWER PLANT COMPONENTS

- Valves
- Heat exchangers
- Pumps
- Spare parts



FLIGHTS

4,065 

TONNES CARRIED

243,290 

AID & RELIEF



FAST RESPONSE HUMANITARIAN AID DELIVERIES TO 93 COUNTRIES

For governments and international relief agencies, from the moment a disaster strikes, it's a race against time to deliver relief supplies and basic infrastructure equipment to literally save lives.

For more than 29 years, they have consistently turned to Volga-Dnepr for help and, over this period, the Group's unique fleet of freighters have been among the first on the scene in disaster areas with urgently-needed humanitarian aid - so far totalling more than 1,150 flights carrying 76,300 tonnes of life saving supplies to those in need in 93 countries.

The Group's fast-response air charter services as well as its extensive scheduled cargo network and the support of local teams of specialists, aircraft and equipment at Volga-Dnepr operations bases in each region of the world, means it is ready to respond to every customer request at a moment's notice.

Volga-Dnepr operates at the forefront of disaster response and has been among the first responders after earthquakes in China, Haiti, India, Nepal and Turkey, tropical storms in the US, Caribbean, Mexico, the Philippines and Vanuatu, and floods and volcanoes in Pakistan and Chile respectively – and was also

heavily involved in the major relief effort after the 2004 tsunami in southeast Asia and in helping to suppress the outbreak of Ebola in West Africa.

Our team of Humanitarian logistics specialists help customers to:

- Expedite the transportation of relief cargoes globally
- Identify the most cost-efficient solutions within the delivery timescale
- Use combinations of charter and schedule cargo services to reduce costs

Volga-Dnepr's Humanitarian Control Tower also constantly monitors extreme weather warnings and updates on natural disasters from the EU/UN Global Disaster Alerting Coordination System to ensure it can proactively alert stakeholders to fleet positioning, availability and solutions at the earliest stage of their response preparations.

AID & RELIEF AIRLIFTS

The types of cargo we deliver:

- Mobile hospitals and other medical equipment
- Temporary housing
- Instruments and medicines
- Water purification equipment
- Laboratory containers
- Generators
- Telecommunications equipment
- Heavy trucks, cranes and other vehicles
- Helicopters
- Boats
- Food supplies
- Clothing and footwear

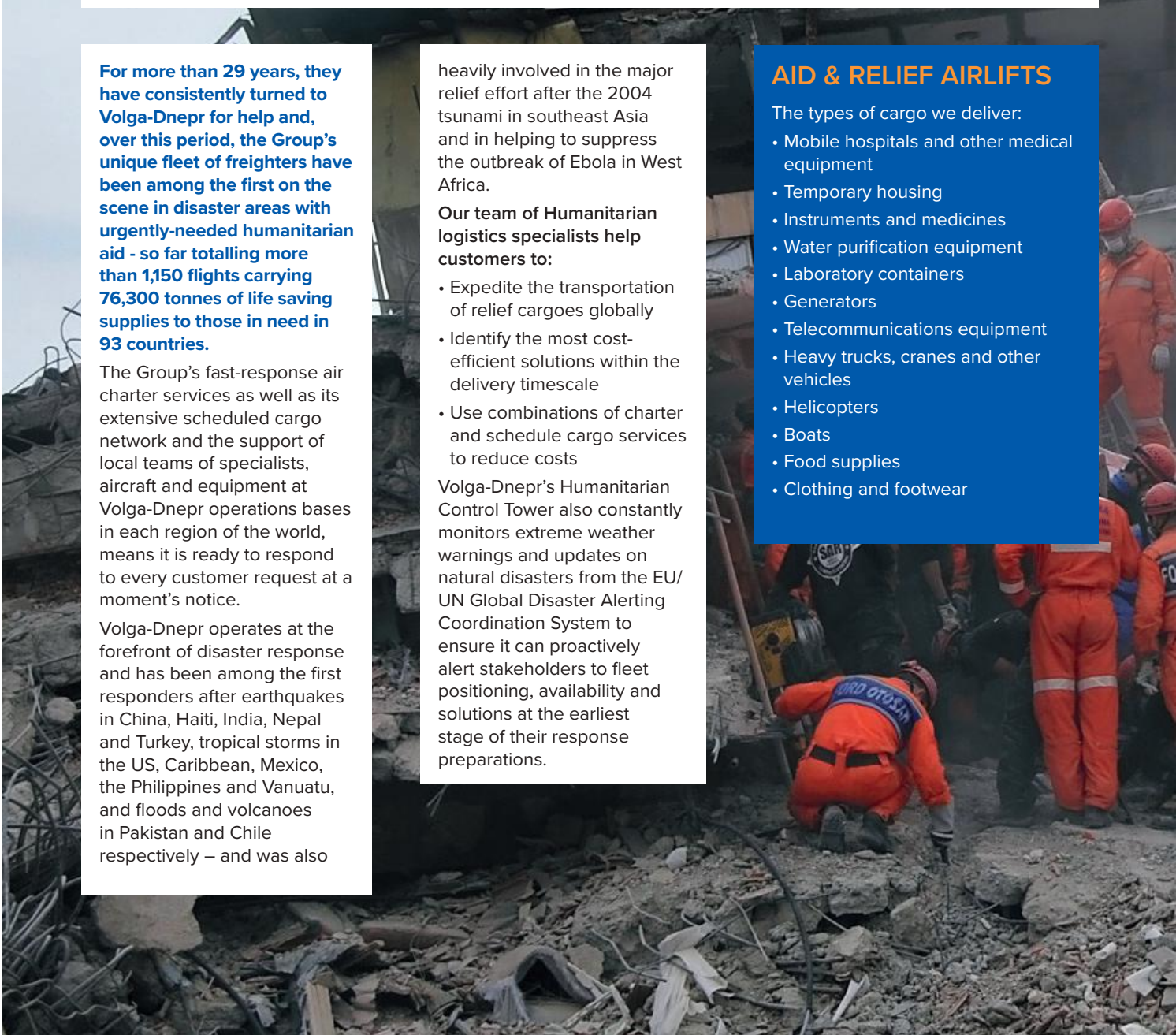

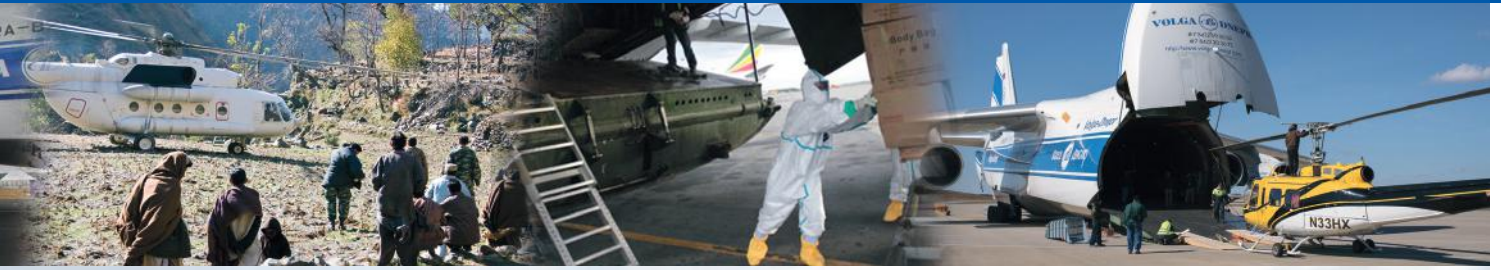

93
COUNTRIES



FLIGHTS

1,152



TONNES CARRIED

76,300



LEARN MORE...



AUTOMOTIVE

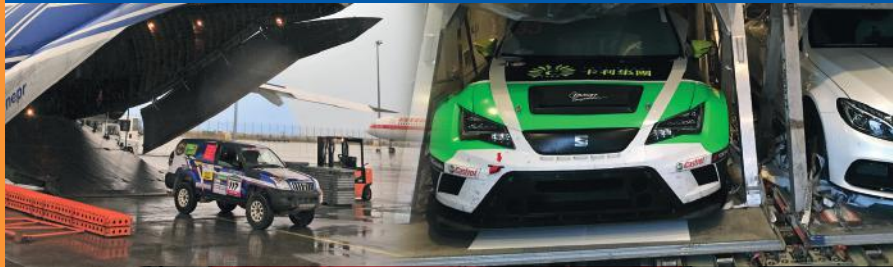

VOLGA-DNEPR SUPPORTS END-TO-END AUTOMOTIVE SUPPLY CHAINS

Volga-Dnepr's specialist services for the Automotive industry incorporate solutions for original equipment manufacturers' (OEM) finished and prototype vehicles, racing cars for motorsport, and parts for tier 1 and tier 2 suppliers.

We've carried new model vehicles for advertising film shoots, top of the range sports cars for their new owners in Asia, fleets of limousines for senior governmental officials, solar-powered cars, cars and jeeps for the Silk Way Rally from Turkmenistan to Germany, and racing cars for the Macau Grand Prix. We've even delivered the World Land Speed Record holder to and from its record-breaking success in the Black Rock Desert in Nevada, US.

For our Automotive logistics experts, no challenge is impossible – not even finding a solution to move trucks used to transport iron ore to one of the remotest parts of Canada or landing on an icy runway with an outside temperature of -50 degrees.

Using our unique double-deck loading system, we can carry as many as 55 vehicles on a single An-124-100 freighter flight.

With our ability to offer both air charter services and a scheduled freighter network connecting Europe, Russia, the US and Asia Pacific, Volga-Dnepr is able to support entire Automotive supply chains – from high volume deliveries of the smallest vehicle components to finished vehicles.

Our specialists will provide all of the information you need to ensure vehicles are prepared for carriage onboard our cargo aircraft and offer advice on ways to make your delivery as efficient as possible.

DOUBLE-DECK CAR LOADING SYSTEM

Using the airline's unique double-deck loading system, Volga-Dnepr can carry up to 55 cars on a single An-124-100 flight.

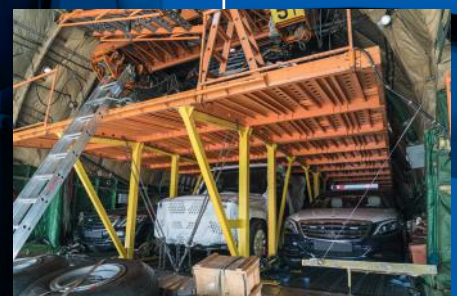

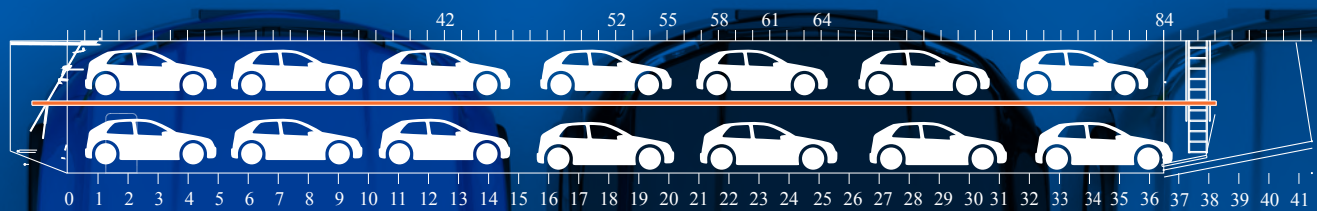

FLIGHTS

956 

TONNES CARRIED

62,000 



PLANNING YOUR TRANSPORTATION

Contacting our team of specialists at the earliest stage in your transportation project will ensure you gain the full benefits of our 29 years of knowledge and expertise, and help you move your cargo on-time and as cost-efficiently as possible.

Key points to consider:

- Talk to us about your end-to-end delivery requirements
- For unique, outsize and heavyweight shipments, many customers involve us at the product design stage in order to ensure that transportation of the finished product is taken into account prior to manufacturing
- Our engineering and planning experts will offer advice such as simple modifications to the cargo, if required, to guarantee it can be loaded, transported and unloaded safely
- We also design and manufacturer bespoke frames to ensure the secure loading and unloading of your cargo and its integrity during transportation
- Understanding your intended shipment routing will minimise aircraft positioning costs
- We can also offer advice and solutions for shipments to remote parts of the world
- Using local teams at our regional Operating Bases, we can source cranes or other equipment needed to ensure the safe and secure unloading of your shipment at destination
- We can also organise and manage ground transportation, including any permits required
- Working alongside our specialists means, on the day of transportation, your cargo will depart for its destination without any time delays or unexpected costs
- Our solutions will ensure full compliance with international safety and security standards



Every time you choose Volga-Dnepr Airlines as your transportation partner, you immediately gain the full support of a 24/7/365 global team of logistics specialists with more than 29 years' experience of solving our customers' most complex and challenging cargo deliveries.

OUR LOCAL TEAMS

Volga  Dnepr

VOLGA-DNEPR AIRLINES

airline.volga-dnepr.com/en

London Heathrow Area,

United Kingdom
+44 1279 661 166
global.sales@volga-dnepr.com
europe.sales@volga-dnepr.com

Ulyanovsk, Russia

+7 8422 590059
sales@volga-dnepr.com

Houston (Texas), USA

+1 832 585 8611
americas.sales@volga-dnepr.com

Sharjah, UAE

+9 716 557 0833
imea.sales@volga-dnepr.com

Beijing, China

+86 10 8447 5502
apac.sales@volga-dnepr.com

Hong Kong, China

+852 2126 7251
apac.sales@volga-dnepr.com

Tokyo, Japan

+81 3 3578 3320
apac.sales@volga-dnepr.com

 AIRBRIDGECARGO

AIRBRIDGECARGO AIRLINES

www.airbridgecargo.com

Head office: Moscow, Russia

+7 495 7862613
info@airbridgecargo.com
service.rus@airbridgecargo.com

Frankfurt am Main, Germany

+49 69 638097 100
service.fra@airbridgecargo.com

Amsterdam, the Netherlands

+31 20 654 9030
sales.ams@airbridgecargo.com

Chicago, USA

+1 773 800 2361
abcsales.ord@airbridgecargo.com
service.usa@airbridgecargo.com

Dallas, USA

Export: +1 469 629 04 78
Import: +1 214 296 03 74
abcsales.dfw@airbridgecargo.com
service.usa@airbridgecargo.com

Los Angeles, USA

+1 310 258 6100
ext. 3902, 3903, 3904, 3905
abcsales.lax@airbridgecargo.com
service.usa@airbridgecargo.com

Hong Kong, China

+852 2215 3928
service.hkg@airbridgecargo.com

Shanghai, China

+86 21 5208 0011
service.pvg@airbridgecargo.com

www.volga-dnepr.com



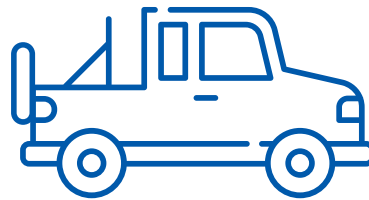
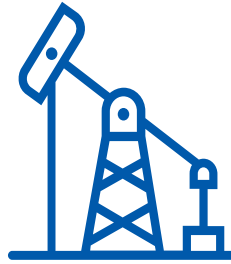
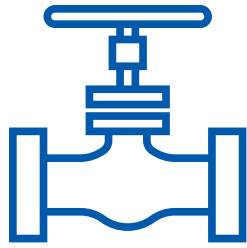

www.volga-dnepr.com